

technical info

18mm MDF core | door is prepared, lacquered, dried and polished | 2mm radius edge | glass is a plain frosted panel

Board Matches:
Egger - U104

*for sizes please refer to www.thesourcebookdirect.co.uk or the current price list.

door range

Lucido Alabaster Gloss - DL.LUS



Doors*

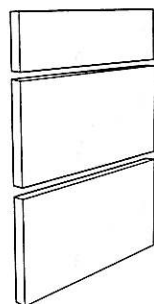

Drawers*

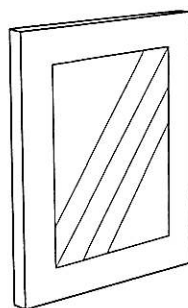

Glazed Doors*

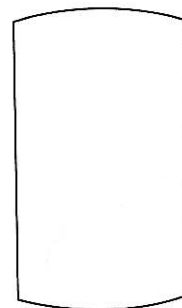

Convex Curved Door
CF1

new



Small Concave Door
CK7¹

new

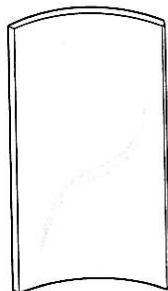

Medium Concave Door
CK8¹

new

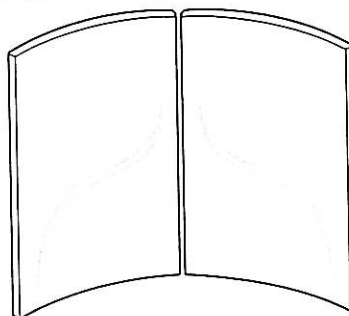

Pair of Large Concave Doors
CK9¹

¹only available on a 3 week paint to order lead-time



accessories

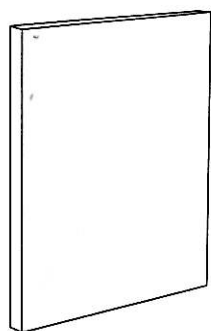

End Panel*

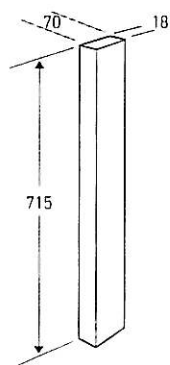

Corner Post
CA0

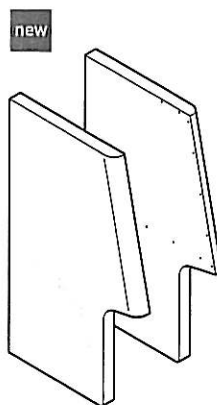

Canopy End Panels
CM9
(Pack 1)

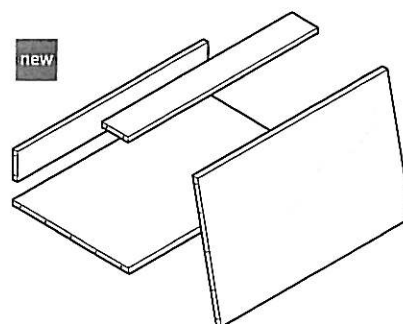

Fascia, Base & Rails
CN1/CN3
(Pack 2)

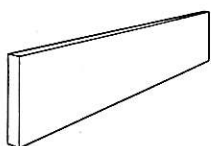

Plinth
C90

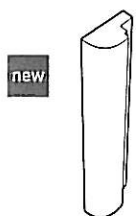

Radius Quadrant
End Moulding
CN4

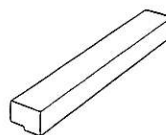

Cornice/Pelmet
C84

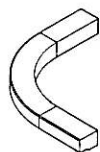

Curved Cornice/Pelmet
CF6

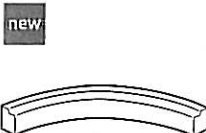

Concave Small
Cornice/Pelmet
CN6'¹



Concave Large
Cornice/Pelmet
CN7'¹



Convex Plinth
CF7

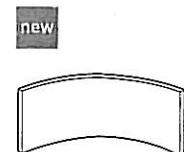

Concave Medium Plinth
CL1'¹

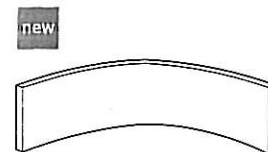

Concave Large Plinth
CL2'¹

¹only available on a 3 week paint to order lead-time



Concave Doors for Lucido, Lucido Senza, Opaco and Opaco Senza

There are three sizes of concave door: Small, Medium & Large. These enable the construction of four different concave installations. They are designed to work with 300mm deep wall units & 560mm deep base units. The concave doors are all 715mm high to fit 720mm high cabinets & multiples thereof.

Concave cornices, palmets & plinths are available to suit the concave doors as appropriate. Check the Price List for range availability.

The drawings here show the shapes & sizes of concave units to suit these doors, also how to set-out the concave units for installation.

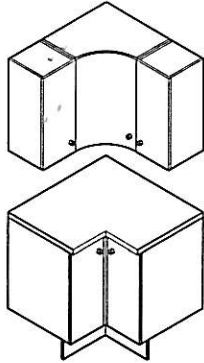

Concave Application 1 uses a *Small* (Rad. 298mm) concave door & 40mm² Corner Post

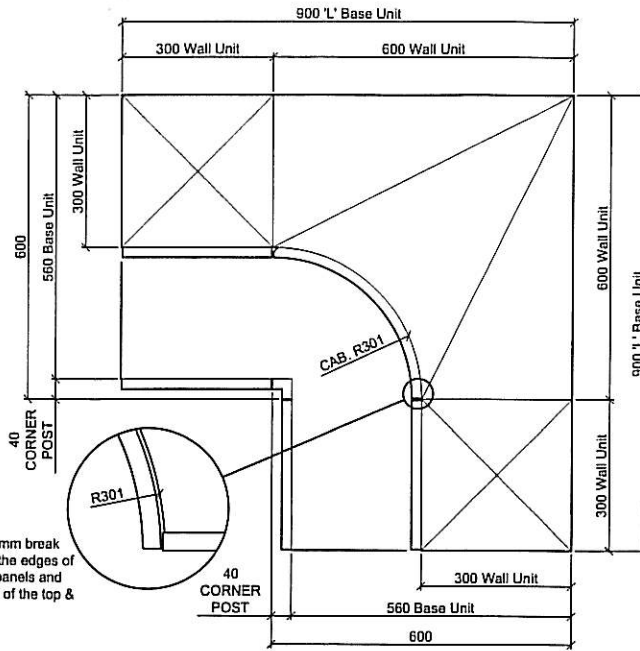

Make a 1mm break between the edges of the side panels and the fronts of the top & base.

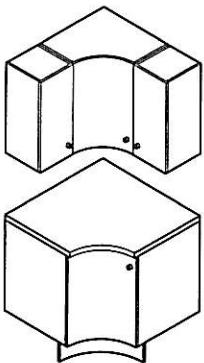

Concave Application 2 uses *Small* (Rad. 298mm) & *Medium* (Rad. 338mm) concave doors

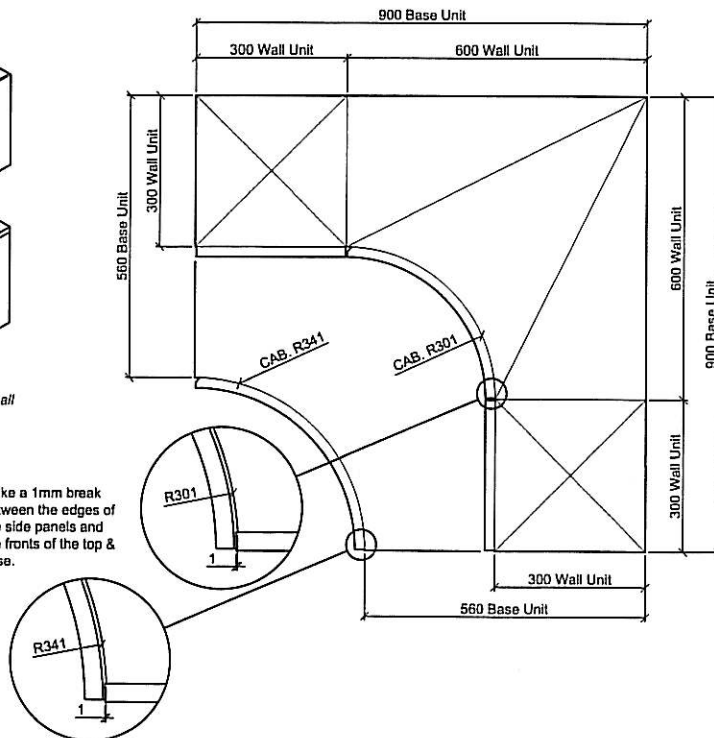

Make a 1mm break between the edges of the side panels and the fronts of the top & base.

The Bevelled Concave Door Edge & Hinges:

Concave doors have bevels down one of their rear vertical edges. This enables them to clear their neighbours as they are opened. Make sure that the drilling for hinges is down the opposite, square edge to the bevelled one!

The bevel goes at the opening side of the door.

Drill for the hinges by the square edge.

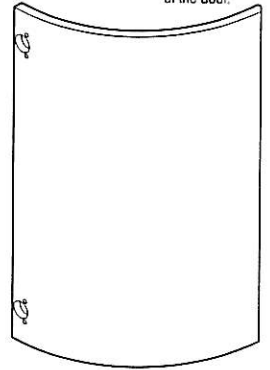

Concave door, rear face

Concave doors can be mounted on a wide range of Ø35mm concealed cup hinges - though it is recommended that wider opening angle versions are used to give best access to the concave cabinets.

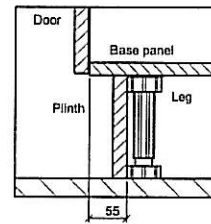

For the curved plinths to fit properly, the rear of the plinths need to be 55mm from the fronts of the cabinets.



Concave Doors for Lucido, Lucido Senza, Opaco and Opaco Senza

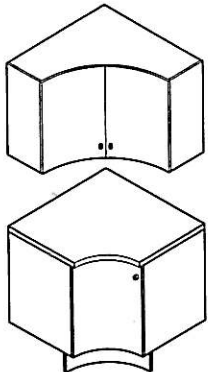

Concave Application 3 uses a Medium & two Large concave doors

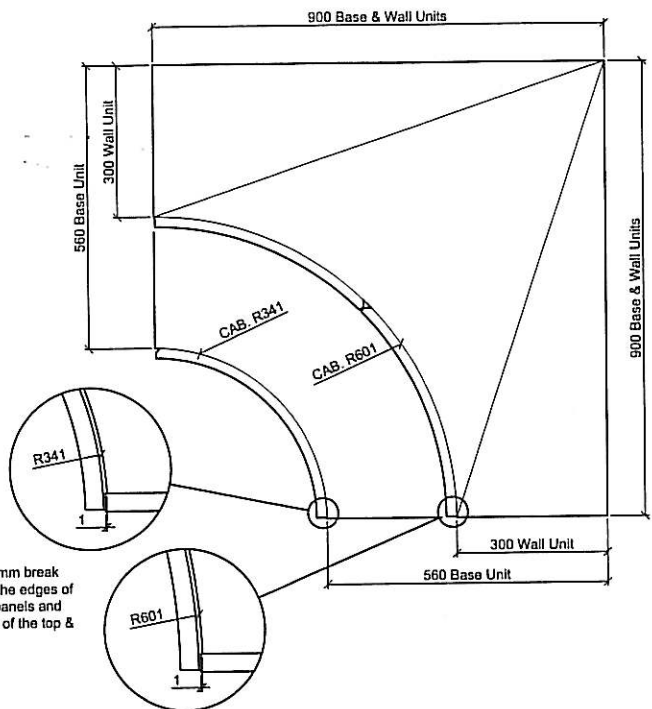

Make a 1mm break between the edges of the side panels and the fronts of the top & base.

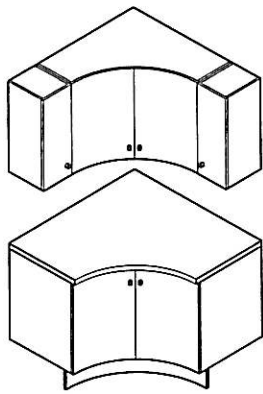

Concave Application 4 uses four Large concave doors & two 255mm wide doors

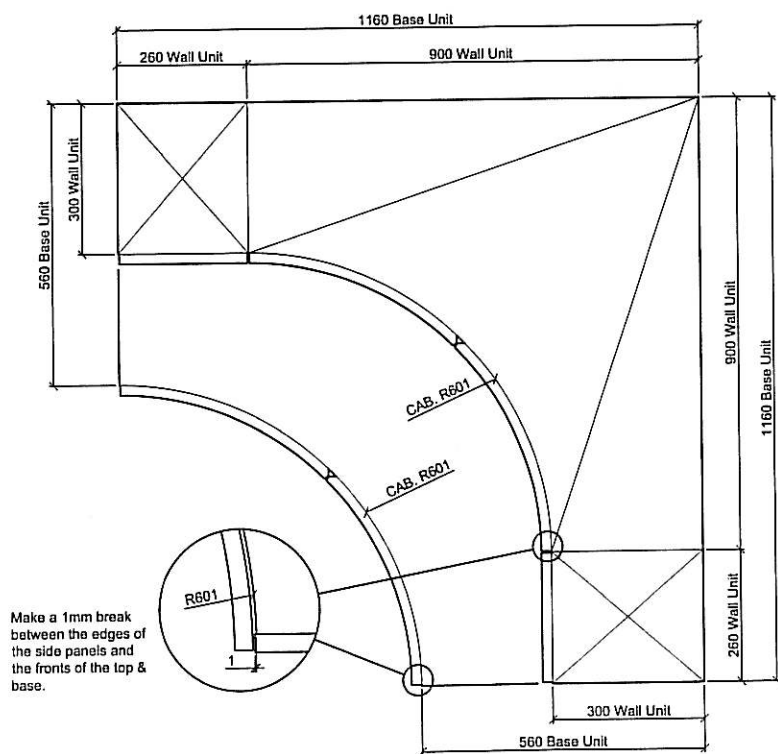

Make a 1mm break between the edges of the side panels and the fronts of the top & base.



Convex Doors for all Ranges:

These Convex doors are 715mm high to fit 720mm high units with a radiused, quarter round shape. The smallest unit they will fit is 300w x 300mm deep. Convex comices, pelmets & plinths are available to suit. Check the Price List for range availability.

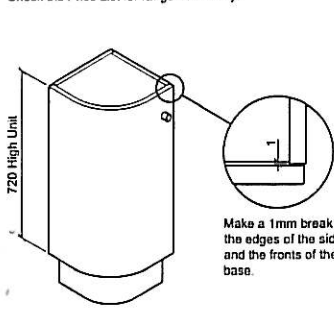

Make a 1mm break between the edges of the side panels and the fronts of the top & base.

The drawings here show the shapes & sizes for convex units to suit these doors. The convex cabinet radius varies according to the range design. Please refer to the chart for the correct radius.

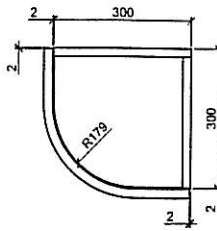

range	convex cabinet
Lucido	
Lucido Senza	radius 179mm
Opaco	
Opaco Senza	
Stamford	radius 189mm

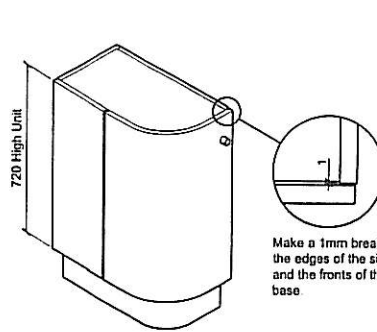

Make a 1mm break between the edges of the side panels and the fronts of the top & base.

Convex plinths are supplied to suit 570mm deep units. To fit them to 560mm deep units, cut 10mm from their longest sides.

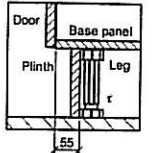
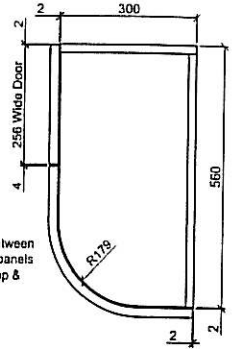

For the curved plinths to fit properly, the rear of the plinths need to be 55mm from the fronts of the cabinets.